

Article number: 2030100M1654A1X
 Description: E+G levelling foot
 GN 30-100-M16-54-A1-X
 Note: X With female thread, Wxternal hexagon

Measures

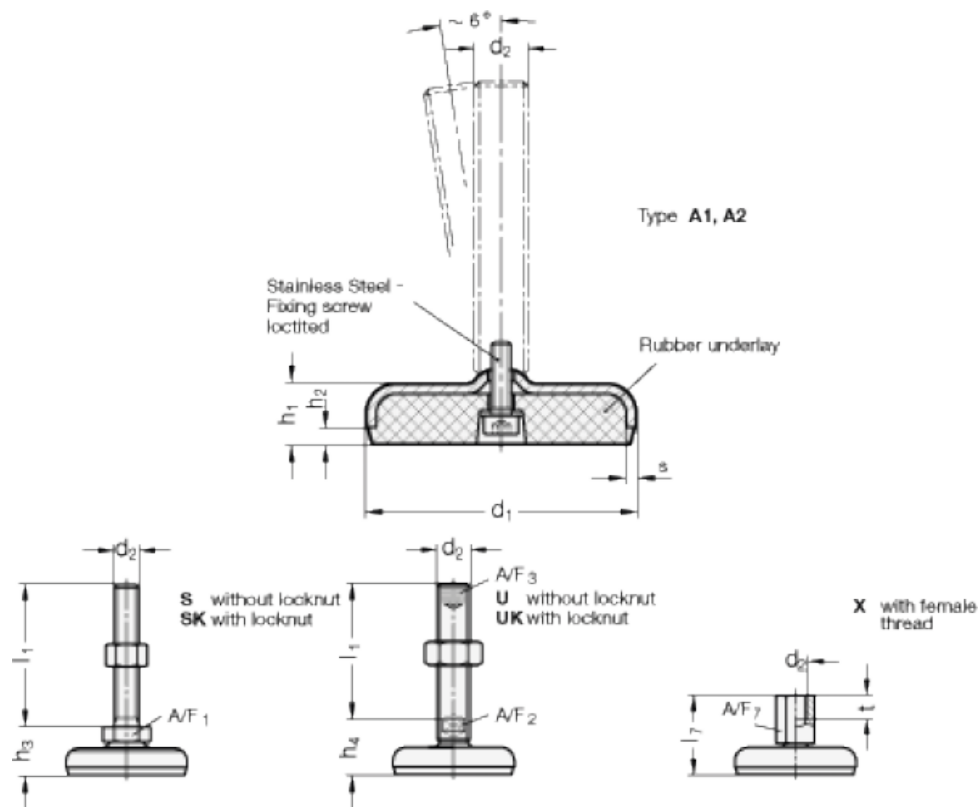

A/F7	=	22
d1	=	100
d2	=	M16
h1	=	22
h2	=	6
l7	=	54
s	=	3
t	=	16